

Connecteur ISP (Femelle)

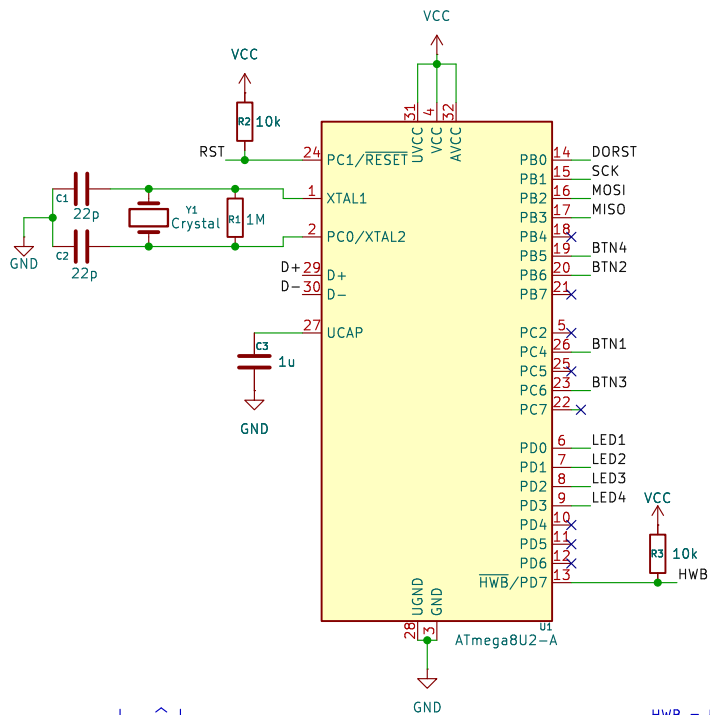

Microcontrôleur

HWB = Hardware Boot
RST = Reset
DORST = Do Reset

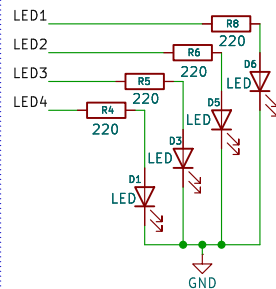

LEDS

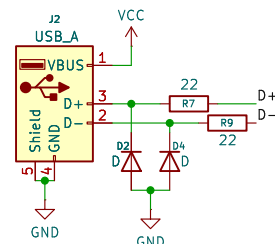

USB

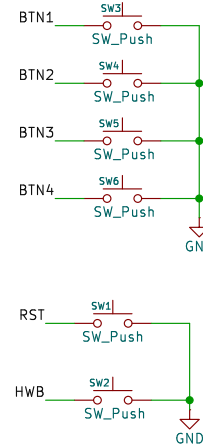

BOUTONS

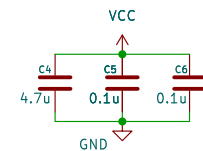

CONDENSATEUR DE DECOUPLAGE

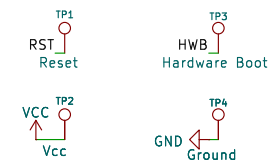

TEST POINT

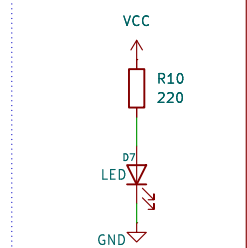

LED ETAT D'ALIMENTATION

Cédric PAYET & Agathe HOUDUSSE
Polytech Lille

Sheet: /
File: payet_houdusse.kicad_sch

Title: Projet PSE S6 – Programmeur AVR

Size: A4 Date: 2025-02-09

KiCad E.D.A. 8.0.5

Rev: 0.6

Id: 1/1